

## Product Overview

NSM2017 is an integrated path current sensor with a very low on-resistance of 0.85mΩ, reducing heat loss on the chip.

NOVOSENSE innovative isolation technology and signal conditioning design can meet high isolation levels while sensing the current flowing through the internal Busbar. A differential Hall pair is used internally, so it has a strong immunity to external stray magnetic fields.

NSM2017 senses the magnetic field generated by the Busbar current flowing under the chip to indirectly detect the current. Compared with the current sampling method of the Shunt+ isolated op-amp, NSM2017 eliminates the need for the primary side power supply and has a simple and convenient layout. At the same time, it has extremely high isolation withstand voltage and lifetime stability.

In high-side current monitoring applications, NSM2017 can reach a working voltage of 1550Vpk, and it can withstand 10kV surge voltage and 13kA surge current without adding any protection devices.

Due to NSM2017 internal accurate temperature compensation algorithm and factory accuracy calibration, this current sensor can maintain good accuracy in the full working temperature range, and the customer does not need to do secondary programming or calibration.

NSM2017 Provides overcurrent protect function.

Support 5V /3.3V power supply (different version)

## Key Features

- High bandwidth and fast response time
- 320kHz bandwidth
- 1.5μs response time

- High-precision current measurement
- Differential Hall sets can immune stray field
- High isolation level that meets UL standards
- Working Voltage for Basic Isolation (VVBI): 1550Vpk / 1097Vrms
- Withstand isolation voltage (VISO): 5000Vrms
- Maximum surge isolation withstand voltage (VIOSM): 10kV
- Maximum surge current (Isurge): 13kA
- CMTI > 100V/ns
- CTI (1)
- Creepage distance/Clearance distance: 8mm
- Fault Overcurrent Protection
- NOVOSENSE innovative ‘Spin Current’ technology makes offset temperature drift very small
- Ratiometric output
- Working temperature: -40°C ~ 125°C
- Primary internal resistance: 0.85mΩ
- Wide body SOIC16 package
- UL62368/EN62368 safety certification
- ROHS
- AEC-Q100 Grade1



Certificate Number:  
CBS 112807 0003 Rev.00  
B 112807 0001 Rev.00



Certificate Number: E520654

## Applications

- Solar system
- Industrial power supply
- Motor control
- OBC/DCDC/PTC Heater
- Charging pile

## Device Information

| Part Number | Package    | Body Size        |
|-------------|------------|------------------|
| NSM2017     | SOW16 (WB) | 10.30mm × 7.50mm |

### Functional Block Diagrams

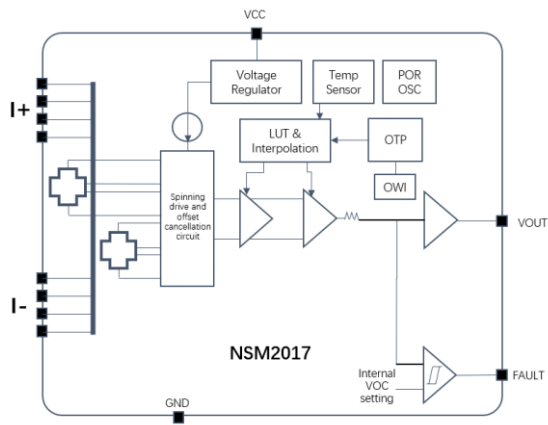

Figure 1. NSM2017 Block Diagram

## INDEX

|  |    |
|--|----|
| 1. PIN CONFIGURATION AND FUNCTIONS.....  | 4  |
| 2. ABSOLUTE MAXIMUM RATINGS.....   | 5  |
| 3. ESD RATINGS.....  | 5  |
| 4. ISOLATION CHARACTERISTICS .....   | 5  |
| 5. SPECIFICATIONS.....   | 6  |
| 5.1. COMMON CHARACTERISTICS (TA= -40°C TO 125°C, VCC = 5V OR 3.3V, UNLESS OTHERWISE SPECIFIED).....        | 6  |
| 5.2. NSM2017-20B3R-Q1SWR CHARACTERISTICS (TA= -40°C TO 125°C, VCC = 3.3V, UNLESS OTHERWISE SPECIFIED)..... | 7  |
| 5.3. NSM2017-20B5R-Q1SWR CHARACTERISTICS (TA= -40°C TO 125°C, VCC = 5V, UNLESS OTHERWISE SPECIFIED).....   | 8  |
| 5.4. NSM2017-40B3R-Q1SWR CHARACTERISTICS (TA= -40°C TO 125°C, VCC = 3.3V, UNLESS OTHERWISE SPECIFIED)..... | 9  |
| 5.5. NSM2017-40B3R2-Q1SWR CHARACTERISTICS (TA= -40°C TO 125°C, VCC = 3.3V, UNLESS OTHERWISE SPECIFIED)...  | 10 |
| 5.6. NSM2017-40B3R4-Q1SWR CHARACTERISTICS (TA= -40°C TO 125°C, VCC = 3.3V, UNLESS OTHERWISE SPECIFIED)...  | 11 |
| 5.7. NSM2017-40B5R-Q1SWR CHARACTERISTICS (TA= -40°C TO 125°C, VCC = 5V, UNLESS OTHERWISE SPECIFIED).....   | 12 |
| 5.8. NSM2017-65B3R-Q1SWR CHARACTERISTICS (TA= -40°C TO 125°C, VCC = 3.3V, UNLESS OTHERWISE SPECIFIED)..... | 13 |
| 5.9. NSM2017-65B3R2-Q1SWR CHARACTERISTICS (TA= -40°C TO 125°C, VCC = 3.3V, UNLESS OTHERWISE SPECIFIED)...  | 14 |
| 5.10. NSM2017-65B3R4-Q1SWR CHARACTERISTICS (TA= -40°C TO 125°C, VCC = 3.3V, UNLESS OTHERWISE SPECIFIED)... | 15 |
| 5.11. NSM2017-65B5R-Q1SWR CHARACTERISTICS (TA= -40°C TO 125°C, VCC = 5V, UNLESS OTHERWISE SPECIFIED).....  | 16 |
| 5.12. NSM2017-75B5R-Q1SWR CHARACTERISTICS (TA= -40°C TO 125°C, VCC = 5V, UNLESS OTHERWISE SPECIFIED).....  | 17 |
| 6. TYPICAL PERFORMANCE CHARACTERISTICS.....  | 18 |
| 6.1. OVERVIEW.....   | 18 |
| 6.2. NSM2017 R VERSION(SINGLE-ENDED RATIO METRIC OUTPUT) .....   | 18 |
| 6.3. OVERCURRENT FAULT PERFORMANCE .....   | 18 |
| 6.4. DEFINITION OF NSM2017 TERMS.....  | 19 |
| 7. APPLICATION NOTE.....   | 22 |
| 7.1. TYPICAL APPLICATION CIRCUIT .....   | 22 |
| 7.2. PCB LAYOUT .....  | 22 |
| 7.3. THERMAL EVALUATION .....  | 23 |
| 8. PACKAGE INFORMATION.....  | 24 |
| SOW16 PACKAGE .....  | 24 |
| 9. ORDERING INFORMATION .....  | 24 |
| 10. TAPE AND REEL INFORMATION.....   | 25 |
| 11. REVISION HISTORY .....   | 26 |

## 1. Pin Configuration and Functions

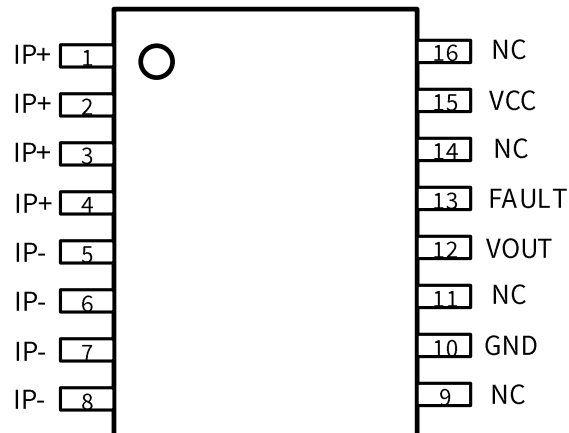

Figure 1.1 NSM2017 Package

Table 1.1 NSM2017 Pin Configuration and Description

| <b>NSM2017Pin No.</b> | <b>Symbol</b> | <b>Function</b>   |
|-----------------------|---------------|---|
| 1-4                   | IP+           | Current flows into the chip, positive direction   |
| 5-8                   | IP-           | Current flows out of the chip, negative direction   |
| 9                     | NC            | No connection (internal circuit, this Pin can also connect to GND Only for Ratiometric Version) |
| 10                    | GND           | Ground  |
| 11                    | NC            | No connection   |
| 12                    | VOUT          | Output voltage  |
| 13                    | FAULT         | Overcurrent Fault, Active low, Open Drain Output  |
| 14                    | NC            | No connection   |
| 15                    | VCC           | Power supply  |
| 16                    | NC            | No connection   |

## 2. Absolute Maximum Ratings

| Parameters           | Symbol                 | Min  | Typ | Max     | Unit | Comments |
|----------------------|------------------------|------|-----|---------|------|----------|
| VCC                  | VCC                    | -0.3 |     | 6.5     | V    |          |
| Vout                 |                        | -0.3 |     | VDD+0.3 | V    |          |
| Other Pins           |                        | -0.3 |     | VDD+0.3 | V    |          |
| Storage temperature  | T <sub>Storage</sub>   | -40  |     | 150     | °C   |          |
| Ambient temperature  | T <sub>operation</sub> | -40  |     | 125     | °C   |          |
| Junction temperature |                        | -40  |     | 150     | °C   |          |

## 3. ESD Ratings

| Parameters                     | Symbol  | Value | Unit |
|--------------------------------|---|-------|------|
| V(ESD) Electrostatic Discharge | Human-Body Model(HBM), per AEC-Q100-002/ESDA-JEDEC JS-001     | ±8000 | V    |
|                                | Charged-Device Model(CDM), per AEC-Q100-011/ESDA-JEDEC JS-002 | ±2000 | V    |

## 4. Isolation Characteristics

| Parameters                          | Symbol             | Rating | Unit             | Comments   |
|-------------------------------------|--------------------|--------|------------------|--|
| Surge Voltage                       | V <sub>surge</sub> | 10     | kV               | Based on IEC61000-4-5 1.2μs/50μs waveform  |
| Surge Current                       | I <sub>surge</sub> | 13     | kA               | Based on IEC61000-4-5 8μs/20μs waveform  |
| Dielectric Strength Test Voltage    | V <sub>ISO</sub>   | 5000   | V <sub>rms</sub> | 60s isolation voltage parameters, according to UL62368-1, 6kV/ 1s insulation performance will be tested before delivery, and partial discharge is verified to be less than 5pC |
| Working Voltage for Basic Isolation | V <sub>WVBI</sub>  | 1097   | V <sub>rms</sub> | Maximum approved working voltage for basic isolation according to UL60950-1 and UL62368-1  |
|                                     |                    | 1550   | V <sub>dc</sub>  |  |
| Common-mode transient immunity      | CMTI               | >100   | V/ns             | The criterion for judging the failure is that the output peak is greater than 100mV and the duration is longer than 1μs  |
| Creepage                            | Creepage           | 8      | mm               | Minimum Creepage   |
| Clearance                           | Clearance          | 8      | mm               | Minimum Clearance  |
| Comparative Tracking Index          | CTI                | >=600  |                  | CTI I  |

## 5. Specifications

### 5.1. Common Characteristics (TA = -40°C to 125°C, VCC = 5V or 3.3V, unless otherwise specified)

| Parameters                                     | Symbol                | Min | Typ     | Max     | Unit      | Comments   |
|--|-----------------------|-----|---------|---------|-----------|--|
| Supply Voltage                                 | V <sub>CC</sub>       | 3   | 3.3     | 3.6     | V         | 3.3V version   |
|  |                       | 4.5 | 5       | 5.5     | V         | 5V version   |
| Supply Current                                 | I <sub>CC</sub>       |     | 12      | 15      | mA        | No load, V <sub>CC</sub> =5V   |
| Primary Conductor Resistance                   | R <sub>P</sub>        |     | 0.85    |         | mΩ        | TA = 25°C  |
| Power-On Time                                  | T <sub>po</sub>       |     | 1       |         | ms        | Recommend customer to read output after 1ms power-on time, before 1ms internal OTP is loading, TA = 25°C |
| Output Capacitance Load <sup>[1][2]</sup>      | C <sub>L</sub>        |     |         | 10      | nF        |  |
| Output Resistance Load <sup>[1][2]</sup>       | R <sub>L</sub>        | 10  |         |         | kΩ        |  |
| Output Short Current                           | I <sub>short</sub>    | -30 |         | 30      | mA        | Short to VCC and short to GND, TA = 25°C   |
| Rail To Rail Output Voltage <sup>[1][2]</sup>  | V <sub>s</sub>        | 0.1 |         | VCC-0.1 | V         | TA = 25°C, CL=1nF, RL=10k to VCC or GND  |
| Common Mode Field Rejection <sup>[1][2]</sup>  | CMFR                  |     | >40     |         | dB        |  |
| Rise Time <sup>[1][2]</sup>                    | T <sub>r</sub>        |     | 1.2     |         | μs        | TA = 25°C, CL=1nF, VCC=5V  |
| Propagation Delay <sup>[1][2]</sup>            | T <sub>pd</sub>       |     | 1.2     |         | μs        | TA = 25°C, CL=1nF, VCC=5V  |
| Response Time <sup>[1][2]</sup>                | T <sub>response</sub> |     | 1.5     | 3       | μs        | TA = 25°C, CL=1nF, VCC=5V  |
| Bandwidth <sup>[1][2]</sup>                    | BW                    |     | 320     |         | kHz       | -3dB bandwidth, TA = 25°C, CL=1nF, VCC=5V  |
| Noise Density <sup>[1][2]</sup>                | ND                    |     | 260     |         | μArms/√Hz | TA = 25°C, CL=1nF, VCC= 5V   |
|  |                       |     | 370     |         | μArms/√Hz | TA = 25°C, CL=1nF, VCC=3.3V  |
| Non-Linearity                                  | E <sub>NL</sub>       |     | ±0.2    |         | %         |  |
| Ratiometric Output Sensitivity Error           | S <sub>ERR</sub>      |     | 0.75    |         | %         | 'R' version, VCC= 4.85V~5.15V, TA = 25°C   |
| Ratiometric Output Offset Error                | V <sub>OUTOR</sub>    |     | 0.1     |         | %         | 'R' version, VCC= 4.85V~5.15V, TA = 25°C   |
| Ratiometric Output Zero Current Output Voltage | QVO                   |     | VCC/2   |         |           | 'RB' version   |
|  |                       |     | 0.1*VCC |         |           | 'RU' version   |

| Parameters               | Symbol           | Min | Typ | Max | Unit | Comments   |
|--------------------------|------------------|-----|-----|-----|------|--|
| Fault Pull-Up Resistance | R <sub>pu</sub>  | 4.7 |     | 100 | kΩ   |  |
| Overcurrent Threshold    | I <sub>ft</sub>  |     | 100 |     | %FS  | User optional,<br>refer to Naming Rules  |
| Fault Hysteresis         | I <sub>hys</sub> |     | 10  |     | %IPR | TA = 25°C, CL=1nF,<br>I <sub>ft</sub> threshold=100%IPR  |
| Fault Response Time      | T <sub>fr</sub>  |     | 1.5 |     | μs   | The time from Overcurrent<br>happened to Fault pin active<br>low, 4.7 kΩ pull-up<br>Resistance |
| Fault Error              |                  |     | ±8  |     | %IPR | TA = 25°C, CL=1nF,<br>I <sub>ft</sub> threshold=100%IPR  |

[1]: Guarantee by design.

[2]: Guaranteed by Bench Validation.

[3]: The increase or decrease of data in 5.X will not send a PCN to the customer if the evaluation does not affect the customer's use.

## 5.2. NSM2017-20B3R-Q1SWR Characteristics (TA= -40°C to 125°C, VCC = 3.3V, unless otherwise specified)

| Parameters                                       | Symbol                   | Min | Typ   | Max | Unit | Comments  |
|--|--------------------------|-----|-------|-----|------|---|
| Current Sensing Range                            | I <sub>pr</sub>          | -20 |       | 20  | A    |   |
| Sensitivity                                      | Sens                     |     | 66    |     | mV/A | I <sub>prmin</sub> <I <sub>pr</sub> <I <sub>prmax</sub> |
| Zero Current Output Voltage                      | V <sub>QVO</sub>         |     | VCC/2 |     | V    | I <sub>pr</sub> =0A                                     |
| Sensitivity Error <sup>[1][2]</sup>              | E <sub>sens</sub>        | -2  |       | 2   | %    | TA = 25°C~125°C   |
|  |                          | -2  |       | 2   | %    | TA = -40°C~25°C   |
| Offset Error <sup>[1][2]</sup>                   | V <sub>OE</sub>          | -10 |       | 10  | mV   | TA = 25°C~125°C, I <sub>pr</sub> =0A                    |
|  |                          | -10 |       | 10  | mV   | TA = -40°C~25°C, I <sub>pr</sub> =0A                    |
| Total Output Error <sup>[1][2]</sup>             | E <sub>total</sub>       | -2  |       | 2   | %    | TA = 25°C~125°C   |
|  |                          | -2  |       | 2   | %    | TA = -40°C~25°C   |
| Overcurrent Threshold                            | I <sub>ft</sub>          |     | 125   |     | %FS  |   |
| Sensitivity Error Lifetime Drift <sup>[3]</sup>  | E <sub>sens_drift</sub>  |     | ±2    |     | %    | After reliability test, TA = 25°C                       |
| Offset Lifetime Drift <sup>[3]</sup>             | V <sub>OE_drift</sub>    |     | ±8    |     | mV   | After reliability test, TA = 25°C                       |
| Total Output Error Lifetime Drift <sup>[3]</sup> | E <sub>total_drift</sub> |     | ±2.1  |     | %    | After reliability test, TA = 25°C                       |

[1]: In production, total error and sensitivity error are measured and calculated at 20A, A single part will not have both the maximum/minimum sensitivity error and maximum/minimum offset voltage.

[2]: Min/Max value is the mean value  $\pm 3\sigma$ . according to the statistical law, 99.73% of the data is in this range Inside.

[3]: The reliability data is implemented in accordance with the AEC-Q100 standard. Typ value is the mean value  $\pm 3\sigma$ . This item is derived from the experimental results with the largest change after the PC, HTS, HAST, UHAST, HTOL, TC and other test data required by AEC-Q100 Grade1 as a reference. , Is the worst case.

### 5.3. NSM2017-20B5R-Q1SWR Characteristics (TA= -40°C to 125°C, VCC = 5V, unless otherwise specified)

| Parameters                                       | Symbol             | Min | Typ       | Max | Unit | Comments                          |
|--|--------------------|-----|-----------|-----|------|-----------------------------------|
| Current Sensing Range                            | $I_{pr}$           | -20 |           | 20  | A    |                                   |
| Sensitivity                                      | Sens               |     | 100       |     | mV/A | $I_{prmin} < I_{pr} < I_{prmax}$  |
| Zero Current Output Voltage                      | $V_{QVO}$          |     | VCC/2     |     | V    | $I_{pr}=0A$                       |
| Sensitivity Error <sup>[1][2]</sup>              | $E_{sens}$         | -2  |           | 2   | %    | TA = 25°C~125°C                   |
|  |                    | -2  |           | 2   | %    | TA = -40°C~25°C                   |
| Offset Error <sup>[1][2]</sup>                   | $V_{OE}$           | -10 |           | 10  | mV   | TA = 25°C~125°C, $I_{pr}=0A$      |
|  |                    | -10 |           | 10  | mV   | TA = -40°C~25°C, $I_{pr}=0A$      |
| Total Output Error <sup>[1][2]</sup>             | $E_{total}$        | -2  |           | 2   | %    | TA = 25°C~125°C                   |
|  |                    | -2  |           | 2   | %    | TA = -40°C~25°C                   |
| Overcurrent Threshold                            | $I_{ft}$           |     | 125       |     | %FS  |                                   |
| Sensitivity Error Lifetime Drift <sup>[3]</sup>  | $E_{sens\_drift}$  |     | $\pm 2$   |     | %    | After reliability test, TA = 25°C |
| Offset Lifetime Drift <sup>[3]</sup>             | $V_{OE\_drift}$    |     | $\pm 8$   |     | mV   | After reliability test, TA = 25°C |
| Total Output Error Lifetime Drift <sup>[3]</sup> | $E_{total\_drift}$ |     | $\pm 2.1$ |     | %    | After reliability test, TA = 25°C |

[1]: In production, total error and sensitivity error are measured and calculated at 20A, A single part will not have both the maximum/minimum sensitivity error and maximum/minimum offset voltage.

[2]: Min/Max value is the mean value  $\pm 3\sigma$ . according to the statistical law, 99.73% of the data is in this range Inside.

[3]: The reliability data is implemented in accordance with the AEC-Q100 standard. Typ value is the mean value  $\pm 3\sigma$ . This item is derived from the experimental results with the largest change after the PC, HTS, HAST, UHAST, HTOL, TC and other test data required by AEC-Q100 Grade1 as a reference. , Is the worst case.



#### 5.4. NSM2017-40B3R-Q1SWR Characteristics (TA= -40°C to 125°C, VCC = 3.3V, unless otherwise specified)

| Parameters                                       | Symbol                   | Min | Typ   | Max | Unit | Comments  |
|--|--------------------------|-----|-------|-----|------|---|
| Current sensing range                            | I <sub>pr</sub>          | -40 |       | 40  | A    |   |
| Sensitivity                                      | Sens                     |     | 33    |     | mV/A | I <sub>prmin</sub> <I <sub>pr</sub> <I <sub>prmax</sub> |
| Zero current output voltage                      | V <sub>QVO</sub>         |     | VCC/2 |     | V    | I <sub>pr</sub> =0A                                     |
| Sensitivity error <sup>[1][2]</sup>              | E <sub>sens</sub>        | -2  |       | 2   | %    | TA = 25°C~125°C   |
|  |                          | -2  |       | 2   | %    | TA = -40°C~25°C   |
| Offset error <sup>[1][2]</sup>                   | V <sub>OE</sub>          | -10 |       | 10  | mV   | TA = 25°C~125°C, I <sub>pr</sub> =0A                    |
|  |                          | -10 |       | 10  | mV   | TA = -40°C~25°C, I <sub>pr</sub> =0A                    |
| Total output error <sup>[1][2]</sup>             | E <sub>total</sub>       | -2  |       | 2   | %    | TA = 25°C~125°C   |
|  |                          | -2  |       | 2   | %    | TA = -40°C~25°C   |
| Overcurrent threshold                            | I <sub>ft</sub>          |     | 125   |     | %FS  |   |
| Sensitivity error lifetime drift <sup>[3]</sup>  | E <sub>sens_drift</sub>  |     | ±2    |     | %    | After reliability test, TA = 25°C                       |
| Offset lifetime drift <sup>[3]</sup>             | V <sub>OE_drift</sub>    |     | ±8    |     | mV   | After reliability test, TA = 25°C                       |
| Total output error lifetime drift <sup>[3]</sup> | E <sub>total_drift</sub> |     | ±2.1  |     | %    | After reliability test, TA = 25°C                       |

[1]: In production, total error and sensitivity error are measured and calculated at 30A, A single part will not have both the maximum/minimum sensitivity error and maximum/minimum offset voltage.

[2]: Min/Max value is the mean value ± 3sigma. according to the statistical law, 99.73% of the data is in this range Inside.

[3]: The reliability data is implemented in accordance with the AEC-Q100 standard. Typ value is the mean value ± 3sigma. This item is derived from the experimental results with the largest change after the PC, HTS, HAST, UHAST, HTOL, TC and other test data required by AEC-Q100 Grade1 as a reference. , Is the worst case.

### 5.5. NSM2017-40B3R2-Q1SWR Characteristics (TA= -40°C to 125°C, VCC = 3.3V, unless otherwise specified)

| Parameters                                       | Symbol                   | Min | Typ   | Max | Unit | Comments  |
|--|--------------------------|-----|-------|-----|------|---|
| Current sensing range                            | I <sub>pr</sub>          | -40 |       | 40  | A    |   |
| Sensitivity                                      | Sens                     |     | 33    |     | mV/A | I <sub>prmin</sub> <I <sub>pr</sub> <I <sub>prmax</sub> |
| Zero current output voltage                      | V <sub>QVO</sub>         |     | VCC/2 |     | V    | I <sub>pr</sub> =0A                                     |
| Sensitivity error <sup>[1][2]</sup>              | E <sub>sens</sub>        | -2  |       | 2   | %    | TA = 25°C~125°C   |
|  |                          | -2  |       | 2   | %    | TA = -40°C~25°C   |
| Offset error <sup>[1][2]</sup>                   | V <sub>OE</sub>          | -10 |       | 10  | mV   | TA = 25°C~125°C, I <sub>pr</sub> =0A                    |
|  |                          | -10 |       | 10  | mV   | TA = -40°C~25°C, I <sub>pr</sub> =0A                    |
| Total output error <sup>[1][2]</sup>             | E <sub>total</sub>       | -2  |       | 2   | %    | TA = 25°C~125°C   |
|  |                          | -2  |       | 2   | %    | TA = -40°C~25°C   |
| Overcurrent threshold                            | I <sub>ft</sub>          |     | 100   |     | %FS  |   |
| Sensitivity error lifetime drift <sup>[3]</sup>  | E <sub>sens_drift</sub>  |     | ±2    |     | %    | After reliability test, TA = 25°C                       |
| Offset lifetime drift <sup>[3]</sup>             | V <sub>OE_drift</sub>    |     | ±8    |     | mV   | After reliability test, TA = 25°C                       |
| Total output error lifetime drift <sup>[3]</sup> | E <sub>total_drift</sub> |     | ±2.1  |     | %    | After reliability test, TA = 25°C                       |

[1]: In production, total error and sensitivity error are measured and calculated at 30A, A single part will not have both the maximum/minimum sensitivity error and maximum/minimum offset voltage.

[2]: Min/Max value is the mean value ± 3sigma. according to the statistical law, 99.73% of the data is in this range Inside.

[3]: The reliability data is implemented in accordance with the AEC-Q100 standard. Typ value is the mean value ± 3sigma. This item is derived from the experimental results with the largest change after the PC, HTS, HAST, UHAST, HTOL, TC and other test data required by AEC-Q100 Grade1 as a reference. , Is the worst case.

### 5.6. NSM2017-40B3R4-Q1SWR Characteristics (TA= -40°C to 125°C, VCC = 3.3V, unless otherwise specified)

| Parameters                                       | Symbol                   | Min | Typ   | Max | Unit | Comments  |
|--|--------------------------|-----|-------|-----|------|---|
| Current sensing range                            | I <sub>pr</sub>          | -40 |       | 40  | A    |   |
| Sensitivity                                      | Sens                     |     | 33    |     | mV/A | I <sub>prmin</sub> <I <sub>pr</sub> <I <sub>prmax</sub> |
| Zero current output voltage                      | V <sub>QVO</sub>         |     | VCC/2 |     | V    | I <sub>pr</sub> =0A                                     |
| Sensitivity error <sup>[1][2]</sup>              | E <sub>sens</sub>        | -2  |       | 2   | %    | TA = 25°C~125°C   |
|  |                          | -2  |       | 2   | %    | TA = -40°C~25°C   |
| Offset error <sup>[1][2]</sup>                   | V <sub>OE</sub>          | -10 |       | 10  | mV   | TA = 25°C~125°C, I <sub>pr</sub> =0A                    |
|  |                          | -10 |       | 10  | mV   | TA = -40°C~25°C, I <sub>pr</sub> =0A                    |
| Total output error <sup>[1][2]</sup>             | E <sub>total</sub>       | -2  |       | 2   | %    | TA = 25°C~125°C   |
|  |                          | -2  |       | 2   | %    | TA = -40°C~25°C   |
| Overcurrent threshold                            | I <sub>ft</sub>          |     | 175   |     | %FS  |   |
| Sensitivity error lifetime drift <sup>[3]</sup>  | E <sub>sens_drift</sub>  |     | ±2    |     | %    | After reliability test, TA = 25°C                       |
| Offset lifetime drift <sup>[3]</sup>             | V <sub>OE_drift</sub>    |     | ±8    |     | mV   | After reliability test, TA = 25°C                       |
| Total output error lifetime drift <sup>[3]</sup> | E <sub>total_drift</sub> |     | ±2.1  |     | %    | After reliability test, TA = 25°C                       |

[1]: In production, total error and sensitivity error are measured and calculated at 30A, A single part will not have both the maximum/minimum sensitivity error and maximum/minimum offset voltage.

[2]: Min/Max value is the mean value ± 3sigma. according to the statistical law, 99.73% of the data is in this range Inside.

[3]: The reliability data is implemented in accordance with the AEC-Q100 standard. Typ value is the mean value ± 3sigma. This item is derived from the experimental results with the largest change after the PC, HTS, HAST, UHAST, HTOL, TC and other test data required by AEC-Q100 Grade1 as a reference. , Is the worst case.

### 5.7. NSM2017-40B5R-Q1SWR Characteristics (TA= -40°C to 125°C, VCC = 5V, unless otherwise specified)

| Parameters                                       | Symbol                   | Min | Typ   | Max | Unit | Comments  |
|--|--------------------------|-----|-------|-----|------|---|
| Current sensing range                            | I <sub>pr</sub>          | -40 |       | 40  | A    |   |
| Sensitivity                                      | Sens                     |     | 50    |     | mV/A | I <sub>prmin</sub> <I <sub>pr</sub> <I <sub>prmax</sub> |
| Zero current output voltage                      | V <sub>QVO</sub>         |     | VCC/2 |     | V    | I <sub>pr</sub> =0A                                     |
| Sensitivity error <sup>[1][2]</sup>              | E <sub>sens</sub>        | -2  |       | 2   | %    | TA = 25°C~125°C   |
|  |                          | -2  |       | 2   | %    | TA = -40°C~25°C   |
| Offset error <sup>[1][2]</sup>                   | V <sub>OE</sub>          | -10 |       | 10  | mV   | TA = 25°C~125°C, I <sub>pr</sub> =0A                    |
|  |                          | -10 |       | 10  | mV   | TA = -40°C~25°C, I <sub>pr</sub> =0A                    |
| Total output error <sup>[1][2]</sup>             | E <sub>total</sub>       | -2  |       | 2   | %    | TA = 25°C~125°C   |
|  |                          | -2  |       | 2   | %    | TA = -40°C~25°C   |
| Overcurrent threshold                            | I <sub>ft</sub>          |     | 125   |     | %FS  |   |
| Sensitivity error lifetime drift <sup>[3]</sup>  | E <sub>sens_drift</sub>  |     | ±2    |     | %    | After reliability test, TA = 25°C                       |
| Offset lifetime drift <sup>[3]</sup>             | V <sub>OE_drift</sub>    |     | ±8    |     | mV   | After reliability test, TA = 25°C                       |
| Total output error lifetime drift <sup>[3]</sup> | E <sub>total_drift</sub> |     | ±2.1  |     | %    | After reliability test, TA = 25°C                       |

[1]: In production, total error and sensitivity error are measured and calculated at 30A, A single part will not have both the maximum/minimum sensitivity error and maximum/minimum offset voltage.

[2]: Min/Max value is the mean value ± 3sigma. according to the statistical law, 99.73% of the data is in this range Inside.

[3]: The reliability data is implemented in accordance with the AEC-Q100 standard. Typ value is the mean value ± 3sigma. This item is derived from the experimental results with the largest change after the PC, HTS, HAST, UHAST, HTOL, TC and other test data required by AEC-Q100 Grade1 as a reference. , Is the worst case.

### 5.8. NSM2017-65B3R-Q1SWR Characteristics (TA= -40°C to 125°C, VCC = 3.3V, unless otherwise specified)

| Parameters                                       | Symbol                   | Min | Typ   | Max | Unit | Comments  |
|--|--------------------------|-----|-------|-----|------|---|
| Current sensing range                            | I <sub>pr</sub>          | -65 |       | 65  | A    |   |
| Sensitivity                                      | Sens                     |     | 20.31 |     | mV/A | I <sub>prmin</sub> <I <sub>pr</sub> <I <sub>prmax</sub> |
| Zero current output voltage                      | V <sub>QVO</sub>         |     | VCC/2 |     | V    | I <sub>pr</sub> =0A                                     |
| Sensitivity error <sup>[1][2]</sup>              | E <sub>sens</sub>        | -2  |       | 2   | %    | TA = 25°C~125°C   |
|  |                          | -2  |       | 2   | %    | TA = -40°C~25°C   |
| Offset error <sup>[1][2]</sup>                   | V <sub>OE</sub>          | -10 |       | 10  | mV   | TA = 25°C~125°C, I <sub>pr</sub> =0A                    |
|  |                          | -10 |       | 10  | mV   | TA = -40°C~25°C, I <sub>pr</sub> =0A                    |
| Total output error <sup>[1][2]</sup>             | E <sub>total</sub>       | -2  |       | 2   | %    | TA = 25°C~125°C   |
|  |                          | -2  |       | 2   | %    | TA = -40°C~25°C   |
| Overcurrent threshold                            | I <sub>ft</sub>          |     | 125   |     | %FS  |   |
| Sensitivity error lifetime drift <sup>[3]</sup>  | E <sub>sens_drift</sub>  |     | ±2    |     | %    | After reliability test, TA = 25°C                       |
| Offset lifetime drift <sup>[3]</sup>             | V <sub>OE_drift</sub>    |     | ±8    |     | mV   | After reliability test, TA = 25°C                       |
| Total output error lifetime drift <sup>[3]</sup> | E <sub>total_drift</sub> |     | ±2.1  |     | %    | After reliability test, TA = 25°C                       |

[1]: In production, total error and sensitivity error are measured and calculated at 30A, A single part will not have both the maximum/minimum sensitivity error and maximum/minimum offset voltage.

[2]: Min/Max value is the mean value ± 3sigma. according to the statistical law, 99.73% of the data is in this range Inside.

[3]: The reliability data is implemented in accordance with the AEC-Q100 standard. Typ value is the mean value ± 3sigma. This item is derived from the experimental results with the largest change after the PC, HTS, HAST, UHAST, HTOL, TC and other test data required by AEC-Q100 Grade1 as a reference. , Is the worst case.

### 5.9. NSM2017-65B3R2-Q1SWR Characteristics (TA= -40°C to 125°C, VCC = 3.3V, unless otherwise specified)

| Parameters                                       | Symbol                   | Min | Typ   | Max | Unit | Comments  |
|--|--------------------------|-----|-------|-----|------|---|
| Current sensing range                            | I <sub>pr</sub>          | -65 |       | 65  | A    |   |
| Sensitivity                                      | Sens                     |     | 20.31 |     | mV/A | I <sub>prmin</sub> <I <sub>pr</sub> <I <sub>prmax</sub> |
| Zero current output voltage                      | V <sub>QVO</sub>         |     | VCC/2 |     | V    | I <sub>pr</sub> =0A                                     |
| Sensitivity error <sup>[1][2]</sup>              | E <sub>sens</sub>        | -2  |       | 2   | %    | TA = 25°C~125°C   |
|  |                          | -2  |       | 2   | %    | TA = -40°C~25°C   |
| Offset error <sup>[1][2]</sup>                   | V <sub>OE</sub>          | -10 |       | 10  | mV   | TA = 25°C~125°C, I <sub>pr</sub> =0A                    |
|  |                          | -10 |       | 10  | mV   | TA = -40°C~25°C, I <sub>pr</sub> =0A                    |
| Total output error <sup>[1][2]</sup>             | E <sub>total</sub>       | -2  |       | 2   | %    | TA = 25°C~125°C   |
|  |                          | -2  |       | 2   | %    | TA = -40°C~25°C   |
| Overcurrent threshold                            | I <sub>ft</sub>          |     | 100   |     | %FS  |   |
| Sensitivity error lifetime drift <sup>[3]</sup>  | E <sub>sens_drift</sub>  |     | ±2    |     | %    | After reliability test, TA = 25°C                       |
| Offset lifetime drift <sup>[3]</sup>             | V <sub>OE_drift</sub>    |     | ±8    |     | mV   | After reliability test, TA = 25°C                       |
| Total output error lifetime drift <sup>[3]</sup> | E <sub>total_drift</sub> |     | ±2.1  |     | %    | After reliability test, TA = 25°C                       |

[1]: In production, total error and sensitivity error are measured and calculated at 30A, A single part will not have both the maximum/minimum sensitivity error and maximum/minimum offset voltage.

[2]: Min/Max value is the mean value ± 3sigma. according to the statistical law, 99.73% of the data is in this range Inside.

[3]: The reliability data is implemented in accordance with the AEC-Q100 standard. Typ value is the mean value ± 3sigma. This item is derived from the experimental results with the largest change after the PC, HTS, HAST, UHAST, HTOL, TC and other test data required by AEC-Q100 Grade1 as a reference. , Is the worst case.

### 5.10. NSM2017-65B3R4-Q1SWR Characteristics (TA= -40°C to 125°C, VCC = 3.3V, unless otherwise specified)

| Parameters                                       | Symbol                   | Min | Typ   | Max | Unit | Comments  |
|--|--------------------------|-----|-------|-----|------|---|
| Current sensing range                            | I <sub>pr</sub>          | -65 |       | 65  | A    |   |
| Sensitivity                                      | Sens                     |     | 20.31 |     | mV/A | I <sub>prmin</sub> <I <sub>pr</sub> <I <sub>prmax</sub> |
| Zero current output voltage                      | V <sub>QVO</sub>         |     | VCC/2 |     | V    | I <sub>pr</sub> =0A                                     |
| Sensitivity error <sup>[1][2]</sup>              | E <sub>sens</sub>        | -2  |       | 2   | %    | TA = 25°C~125°C   |
|  |                          | -2  |       | 2   | %    | TA = -40°C~25°C   |
| Offset error <sup>[1][2]</sup>                   | V <sub>OE</sub>          | -10 |       | 10  | mV   | TA = 25°C~125°C, I <sub>pr</sub> =0A                    |
|  |                          | -10 |       | 10  | mV   | TA = -40°C~25°C, I <sub>pr</sub> =0A                    |
| Total output error <sup>[1][2]</sup>             | E <sub>total</sub>       | -2  |       | 2   | %    | TA = 25°C~125°C   |
|  |                          | -2  |       | 2   | %    | TA = -40°C~25°C   |
| Overcurrent threshold                            | I <sub>ft</sub>          |     | 175   |     | %FS  |   |
| Sensitivity error lifetime drift <sup>[3]</sup>  | E <sub>sens_drift</sub>  |     | ±2    |     | %    | After reliability test, TA = 25°C                       |
| Offset lifetime drift <sup>[3]</sup>             | V <sub>OE_drift</sub>    |     | ±8    |     | mV   | After reliability test, TA = 25°C                       |
| Total output error lifetime drift <sup>[3]</sup> | E <sub>total_drift</sub> |     | ±2.1  |     | %    | After reliability test, TA = 25°C                       |

[1]: In production, total error and sensitivity error are measured and calculated at 30A, A single part will not have both the maximum/minimum sensitivity error and maximum/minimum offset voltage.

[2]: Min/Max value is the mean value ± 3sigma. according to the statistical law, 99.73% of the data is in this range Inside.

[3]: The reliability data is implemented in accordance with the AEC-Q100 standard. Typ value is the mean value ± 3sigma. This item is derived from the experimental results with the largest change after the PC, HTS, HAST, UHAST, HTOL, TC and other test data required by AEC-Q100 Grade1 as a reference. , Is the worst case.

### 5.11. NSM2017-65B5R-Q1SWR Characteristics (TA= -40°C to 125°C, VCC = 5V, unless otherwise specified)

| Parameters                                       | Symbol                   | Min | Typ   | Max | Unit | Comments  |
|--|--------------------------|-----|-------|-----|------|---|
| Current sensing range                            | I <sub>pr</sub>          | -65 |       | 65  | A    |   |
| Sensitivity                                      | Sens                     |     | 30.77 |     | mV/A | I <sub>prmin</sub> <I <sub>pr</sub> <I <sub>prmax</sub> |
| Zero current output voltage                      | V <sub>QVO</sub>         |     | VCC/2 |     | V    | I <sub>pr</sub> =0A                                     |
| Sensitivity error <sup>[1][2]</sup>              | E <sub>sens</sub>        | -2  |       | 2   | %    | TA = 25°C~125°C   |
|  |                          | -2  |       | 2   | %    | TA = -40°C~25°C   |
| Offset error <sup>[1][2]</sup>                   | V <sub>OE</sub>          | -10 |       | 10  | mV   | TA = 25°C~125°C, I <sub>pr</sub> =0A                    |
|  |                          | -10 |       | 10  | mV   | TA = -40°C~25°C, I <sub>pr</sub> =0A                    |
| Total output error <sup>[1][2]</sup>             | E <sub>total</sub>       | -2  |       | 2   | %    | TA = 25°C~125°C   |
|  |                          | -2  |       | 2   | %    | TA = -40°C~25°C   |
| Overcurrent threshold                            | I <sub>ft</sub>          |     | 125   |     | %FS  |   |
| Sensitivity error lifetime drift <sup>[3]</sup>  | E <sub>sens_drift</sub>  |     | ±2    |     | %    | After reliability test, TA = 25°C                       |
| Offset lifetime drift <sup>[3]</sup>             | V <sub>OE_drift</sub>    |     | ±8    |     | mV   | After reliability test, TA = 25°C                       |
| Total output error lifetime drift <sup>[3]</sup> | E <sub>total_drift</sub> |     | ±2.1  |     | %    | After reliability test, TA = 25°C                       |

[1]: In production, total error and sensitivity error are measured and calculated at 30A, A single part will not have both the maximum/minimum sensitivity error and maximum/minimum offset voltage.

[2]: Min/Max value is the mean value ± 3sigma. according to the statistical law, 99.73% of the data is in this range Inside.

[3]: The reliability data is implemented in accordance with the AEC-Q100 standard. Typ value is the mean value ± 3sigma. This item is derived from the experimental results with the largest change after the PC, HTS, HAST, UHAST, HTOL, TC and other test data required by AEC-Q100 Grade1 as a reference. , Is the worst case.



### 5.12. NSM2017-75B5R-Q1SWR Characteristics (TA= -40°C to 125°C, VCC = 5V, unless otherwise specified)

| Parameters                                       | Symbol                   | Min | Typ   | Max | Unit | Comments  |
|--|--------------------------|-----|-------|-----|------|---|
| Current sensing range                            | I <sub>pr</sub>          | -75 |       | 75  | A    |   |
| Sensitivity                                      | Sens                     |     | 26.67 |     | mV/A | I <sub>prmin</sub> <I <sub>pr</sub> <I <sub>prmax</sub> |
| Zero current output voltage                      | V <sub>QVO</sub>         |     | VCC/2 |     | V    | I <sub>pr</sub> =0A                                     |
| Sensitivity error <sup>[1][2]</sup>              | E <sub>sens</sub>        | -2  |       | 2   | %    | TA = 25°C~125°C   |
|  |                          | -2  |       | 2   | %    | TA = -40°C~25°C   |
| Offset error <sup>[1][2]</sup>                   | V <sub>OE</sub>          | -10 |       | 10  | mV   | TA = 25°C~125°C, I <sub>pr</sub> =0A                    |
|  |                          | -10 |       | 10  | mV   | TA = -40°C~25°C, I <sub>pr</sub> =0A                    |
| Total output error <sup>[1][2]</sup>             | E <sub>total</sub>       | -2  |       | 2   | %    | TA = 25°C~125°C   |
|  |                          | -2  |       | 2   | %    | TA = -40°C~25°C   |
| Overcurrent threshold                            | I <sub>ft</sub>          |     | 125   |     | %FS  |   |
| Sensitivity error lifetime drift <sup>[3]</sup>  | E <sub>sens_drift</sub>  |     | ±2    |     | %    | After reliability test, TA = 25°C                       |
| Offset lifetime drift <sup>[3]</sup>             | V <sub>OE_drift</sub>    |     | ±8    |     | mV   | After reliability test, TA = 25°C                       |
| Total output error lifetime drift <sup>[3]</sup> | E <sub>total_drift</sub> |     | ±2.1  |     | %    | After reliability test, TA = 25°C                       |

[1]: In production, total error and sensitivity error are measured and calculated at 30A, A single part will not have both the maximum/minimum sensitivity error and maximum/minimum offset voltage.

[2]: Min/Max value is the mean value ± 3sigma. according to the statistical law, 99.73% of the data is in this range Inside.

[3]: The reliability data is implemented in accordance with the AEC-Q100 standard. Typ value is the mean value ± 3sigma. This item is derived from the experimental results with the largest change after the PC, HTS, HAST, UHAST, HTOL, TC and other test data required by AEC-Q100 Grade1 as a reference. , Is the worst case.

\*In the fifth chapter, the increase or decrease of the material number and the tightening of the parameter range, NOVOSENSE reserves the right not to send PCN to the customer, unless the expansion of the parameter range affects the customer's use and product performance.

## 6. Typical Performance Characteristics

### 6.1. Overview

NSM2017 current sensor can accurately measure AC/DC current while minimizing the overall measurement cost. Current sensors based on the Hall principle can be widely used in all current monitoring applications such as consumer, industrial, and automotive. Compared with current transformers, the extremely small size of NSM2017 SOW16 can help customers reduce the overall PCB area; compared to Shunt + isolated op amps, NSM2017 only needs low-voltage side power supply, reducing the inconvenience of isolated op amps requiring power supply for both high and low sides. When using NSM2017, you only need to string the primary side pin into the measured current. According to the part of Maxwell equations about electricity and magnetism, a magnetic field will be generated around the energized conductor of the primary side. The Hall and conditioning amplifier circuits in NSM2017 will convert magnetic field into an output voltage, and the output voltage increases or decreases in proportion to the input current.

Benefiting from the typical value of the primary resistance of NSM2017 is only 0.85mohm, as long as the customer conducts a reasonable heat dissipation design, the temperature rise brought by the measurement of large current can be effectively reduced.

At the same time, NSM2017 uses dual Hall sampling internally, the common mode magnetic field brought by the outside world can be effectively reduced. According to the measured typical value, if the 100G common mode magnetic field acts vertically on the chip, it will only bring an error of less than 1G in the output. (Equivalent to input). Because NSM2017 has a good ability to resist common-mode magnetic fields, it can still maintain excellent performance in motor control or some harsh current measurement environments.

### 6.2. NSM2017 R Version(single-ended ratiometric output)

The NSM2017 R version is a ratiometric output mode. The definition of ratiometric output is that if the power supply  $V_{cc}$  changes by 1% under ideal conditions, the output  $V_{out}$  will also change by 1% under ideal conditions. In this mode, the output calculation formula is as follows :

$$V_{out} = S_{V_{cc}} * I + QVO_{V_{cc}}$$

$S_{V_{cc}}$  is the sensitivity under the current supply voltage, and  $QVO_{V_{cc}}$  is the zero point voltage under the current supply voltage,  $V_{CC}/2$  (bidirectional version) or  $0.1 V_{CC}$  (unidirectional version). If the customer chooses the measurement range of  $\pm 20A$ , then under the 5V power supply, the sensitivity is  $4V/40A=100mV/A$ ; if the power supply voltage is changed to 4.8V, the sensitivity will become  $100mV/A*4.8V/5V$  under ideal conditions  $5V=96mV/A$ , and the zero point voltage changes to  $2.5V*4.8V/5V=2.4V$  at the same time. Due to the above proportional characteristics, the NSM2017 R version is mostly used in applications where the ADC power supply (reference) and the current sensor power supply use the same power supply.

### 6.3. Overcurrent Fault Performance

NSM2017 has overcurrent protect function. When the primary current exceeds the overcurrent threshold, the internal error comparator reverses, driving Open Drain Output to work, and the Fault pin is pulled down.

Other ranges can be customized as required. The optional ranges of overcurrent threshold as follow:

| Parameters            | range(%FS) |
|-----------------------|------------|
| Overcurrent threshold | 75         |
|                       | 100        |
|                       | 125        |
|                       | 150        |
|                       | 175        |

Overcurrent Fault is triggered when the primary current (positive or negative current) exceeds the overcurrent threshold. Fault is cleared when the absolute value of the primary current is less than the current threshold set minus current hysteresis.  $T_{fr}$  is Fault Response time: the time from the primary current meets the overcurrent condition to Fault pin is pulled down. The timing of overcurrent protection is as follows:

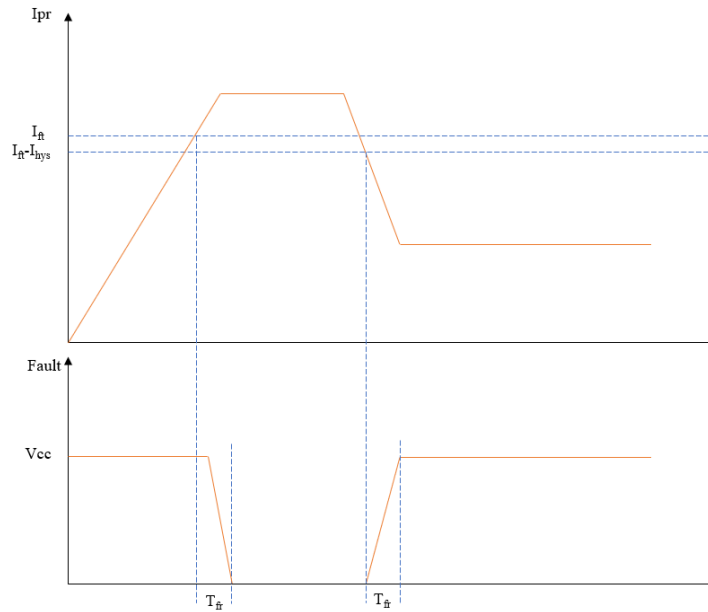

Figure 6.1 NSM2017 Overcurrent Performance

### 6.4. Definition of NSM2017 Terms

#### Power-on time (Tpo)

When the power supply climbs from 0 to the chip's working range, NSM2017 needs some time to establish the internal working logic. Tpo time is defined as: the time from the power supply climbing to  $V_{ccmin}$  to the output reaching the steady state within  $\pm 10\%$ , As shown below:

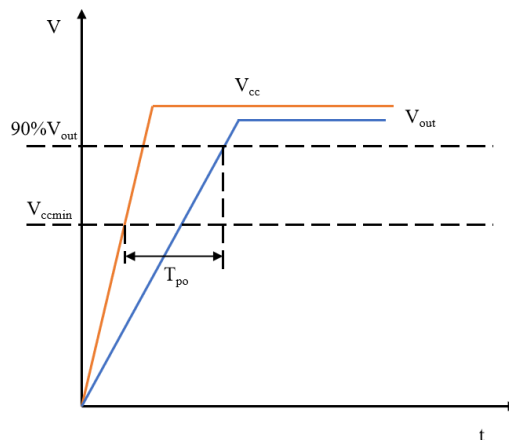

Figure 6.2 NSM2017 Power-on time

#### Rise time (Tr)

The time from 10% to 90% of the output signal is defined as the output rise time. For step input signals, there is such an approximate relationship between the rise time and bandwidth of the output signal:  $f(-3dB) = 0.35/Tr$ .

**Propagation delay (Tpd)**

The time from 20% of the primary current to 20% of the output signal is defined as the output propagation delay time.

**Response time (Tresponse)**

The time from 90% of the primary current to 90% of the output signal is defined as the output response time.

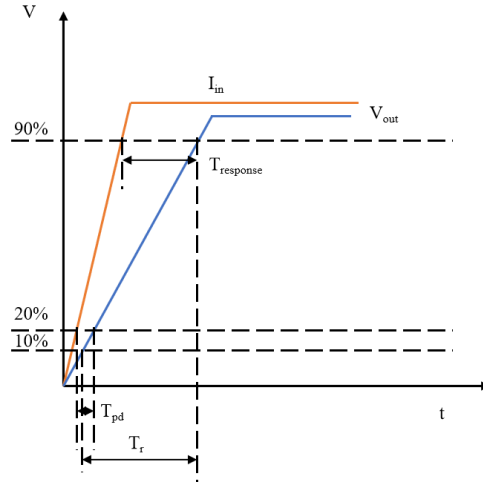

Figure 6.3 NSM2017 response time

**Sensitivity and sensitivity error**

Sensitivity is defined as the ratio of the output voltage proportional to the primary input current. Sensitivity is the slope of the curve in the figure below.

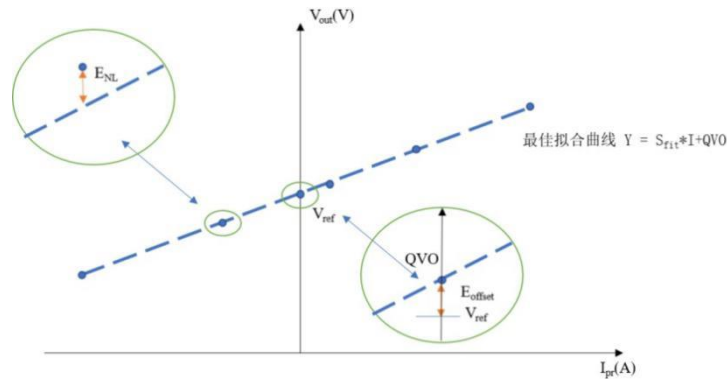

Figure 6.4 NSM2017 Sensitivity and error

The sensitivity error is defined as the deviation between the slope of the best-fit curve and the slope of the ideal curve. The slope of the best-fit curve comes from the measured value:

$$E_{sens} = \frac{(S_{fit} - S_{ideal})}{S_{ideal}} * 100\%$$

**Offset error**

The zero current output error is defined as the difference between the output voltage and the reference voltage when the primary current is 0A, Vref here is VCC/2 or 0.1\*VCC (R version):

$$E_{offset} = QVO - V_{ref}$$

### Non-linearity error

The linearity error is defined as the error from the maximum deviation point of the best-fit curve to the full scale. The mathematical expression is as follows:

$$E_{NL} = \frac{V_{NL}}{FS} * 100\%$$

among them:

$V_{NL} = V_{outmax} - (S_{fit} * I_{max} + QVO)$ ,  $V_{NL}$  is the output error of the maximum deviation point;

$FS$  is Full scale of output voltage;

$V_{outmax}$  is the output voltage furthest from the fitted curve;

$I_{max}$  is the primary current furthest from the fitted curve;

### Total error

The total error is defined as the error between the actual given current and the current measured by the chip, in other words, the difference between the actual output voltage and the ideal output voltage. It should be known that in different current ranges, the factors that dominate the total error are different. If it is under low current measurement, the zero point error is the main source of error; if under high current measurement, the total error caused by the zero point error is very small, and the dominant error is the sensitivity error.

$$E_{total}(I_{pr}) = \frac{V_{outideal}(I_{pr}) - V_{out}(I_{pr})}{FS}$$

### Ratiometric output sensitivity error

The ratiometric output sensitivity error is defined as the error of the sensitivity change with the change of  $V_{cc}$ . In a perfectly ideal situation, when  $V_{cc}$  changes by 10%, the sensitivity should also change by 10%. The error is expressed by the following formula:

$$S_{ERR} = 100\% \times \left\{ \left( \frac{S(V_{CC})}{S(5V)} \right) - \left( \frac{V_{CC}}{5} \right) \right\}$$

### Ratiometric output offset error

The offset error of the ratiometric output is defined as the error condition of the zero-point change with the change of  $V_{cc}$ . In a ideal situation, the output zero point is  $V_{cc}/2$ ,  $V_{cc}$  changes 10%, and the zero point should also change 10%. The error is expressed by the following formula:

$$V_{out0R} = 100\% \times \left\{ \left( \frac{V_{out0}(V_{CC})}{V_{out0}(5V)} \right) - \left( \frac{V_{CC}}{5} \right) \right\}$$

## 7. Application Note

### 7.1. Typical Application Circuit

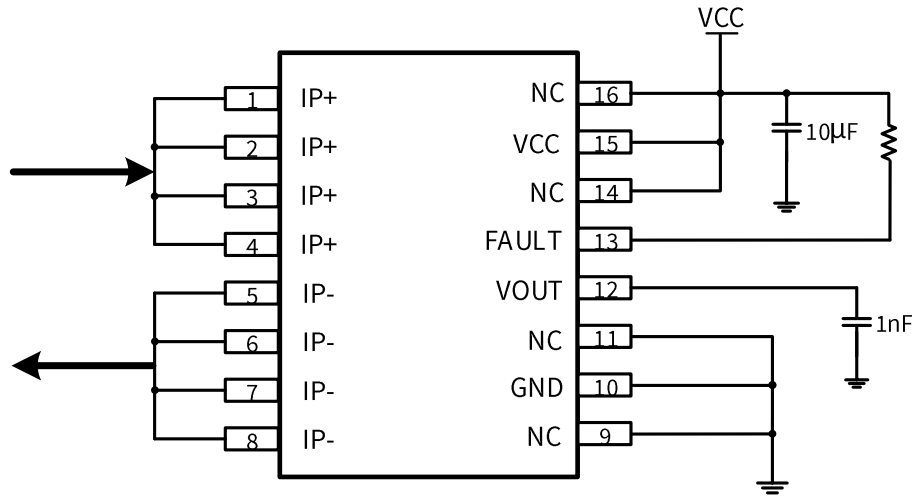

Figure 7.1 Typical application diagram

### 7.2. PCB Layout

For NSM2017 in high-current monitoring applications, a reasonable layout will make the system heat dissipation faster and better. The copper area on the NSM2017 Demo board is 21mm\*18mm (very small copper area is used to illustrate the worse situation, rather than a large copper area), the top layer and the bottom layer are 2oz copper thick. Under this layout, after 30 minutes the surface temperature of the chip is as shown in the figure 7.2 (IP=35A). The highest point temperature is around 70°C. Foreign competitors can reach 90°C under the same layout. . The reason why NSM2017 is better than competitors for heat dissipation is due to the use of packaging materials with better heat dissipation coefficients and a copper frame with better heat dissipation coefficients. If customers want to achieve better heat dissipation, they can use multi-layer boards and thicken the copper thickness to achieve it, and can use active heat dissipation solutions in the system, such as adding heat sinks and fans. If you need to use the NSM2017 Demo board to evaluate the performance of this current sensor, please contact NOVOSENSE sales team for support.

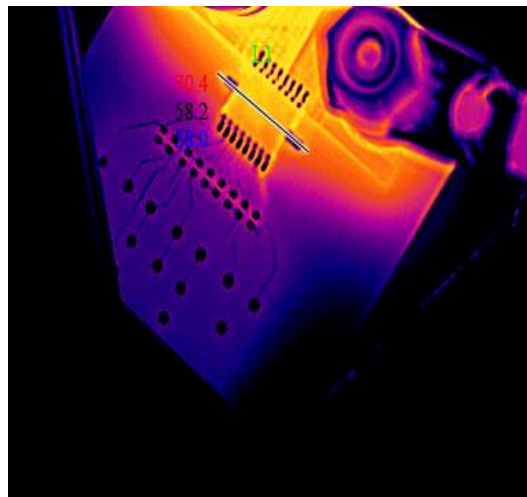

Figure 7.2 NSM2017 PCB Layout

### 7.3. Thermal Evaluation

The thermal evaluation experiment is tested at room temperature, which mainly illustrates the temperature rise of the NSM2017 current sensor under different currents. With these data and the above-mentioned layout guide, customers can design heat dissipation according to actual application requirements. The ambient temperature in this experiment is room temperature. The temperature rise test is based on the above demo board. There is no external active heat dissipation device (such as a fan, etc.). The relationship between junction temperature and time is measured. 20 minutes of temperature data are collected. Under normal circumstances, the junction temperature basically fixed in about 10 minutes, and the specific test data are as follows:

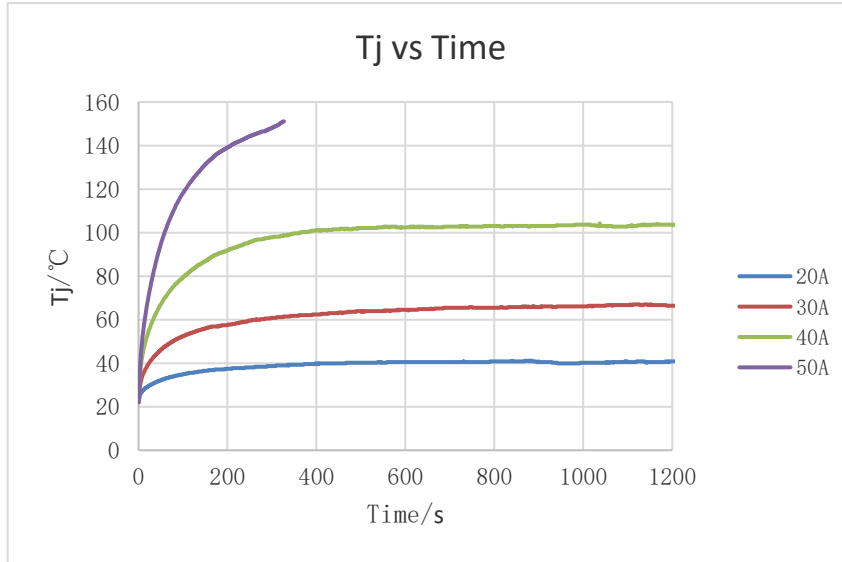

Figure 7.3 NSM2017 Junction temperature vs. Different continues current

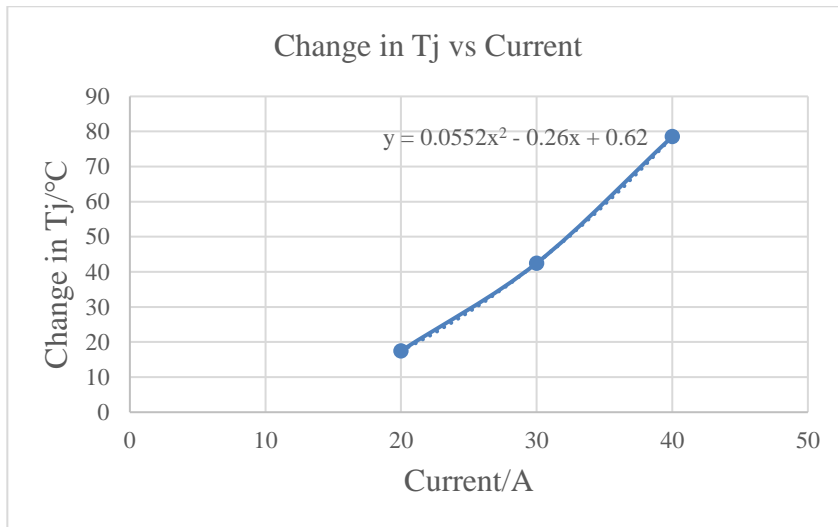

Figure 7.4 NSM2017 Estimation function of junction temperature at different currents (PCB is in the worst case)

It is important to note that the above temperature rise experiment data is only based on the Demo board, in order to reflect the relationship between NSM2017 current and temperature in the worst case. Customers can reduce the temperature rise of Tj by increasing or thickening the copper area of the PCB, using multi-layer boards, or adding active heat dissipation devices such as fans. If customers compare NSM2017 with other competing products, please refer to the same PCB design instead of using specially designed PCB provided by competing products. NOVOSENSE can provide a 16-pin general-purpose Demo board for comparison of temperature rises of competing products.

## 8. Package Information

### SOW16 package

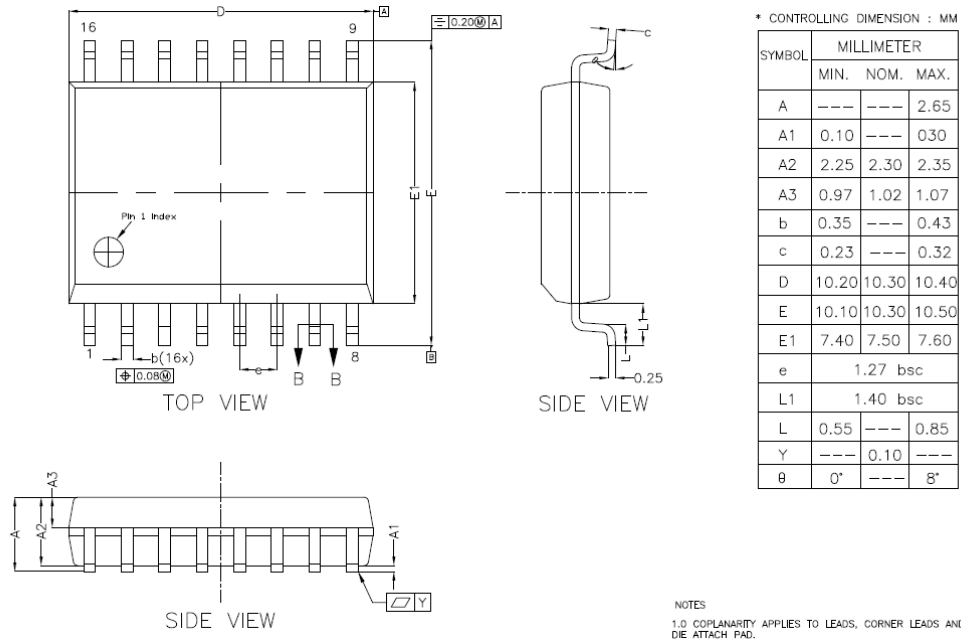

Figure 8.1 SOW16 Package Shape and Dimension in millimeters and (inches)

## 9. Ordering Information

| Part number          | Primary current(A) | Power supply(V) | Sensitivity (mV/A) | OCD threshold (%FullScale) | MSL | Package |
|----------------------|--------------------|-----------------|--------------------|----------------------------|-----|---------|
| NSM2017-20B3R-Q1SWR  | ±20                | 3.3             | 66                 | 125%                       | 3   | SOW16   |
| NSM2017-20B5R-Q1SWR  | ±20                | 5               | 100                | 125%                       | 3   | SOW16   |
| NSM2017-40B3R-Q1SWR  | ±40                | 3.3             | 33                 | 125%                       | 3   | SOW16   |
| NSM2017-40B3R2-Q1SWR | ±40                | 3.3             | 33                 | 100%                       | 3   | SOW16   |
| NSM2017-40B3R4-Q1SWR | ±40                | 3.3             | 33                 | 175%                       | 3   | SOW16   |
| NSM2017-40B5R-Q1SWR  | ±40                | 5               | 50                 | 125%                       | 3   | SOW16   |
| NSM2017-65B3R-Q1SWR  | ±65                | 3.3             | 20.31              | 125%                       | 3   | SOW16   |
| NSM2017-65B3R2-Q1SWR | ±65                | 3.3             | 20.31              | 100%                       | 3   | SOW16   |
| NSM2017-65B3R4-Q1SWR | ±65                | 3.3             | 20.31              | 175%                       | 3   | SOW16   |
| NSM2017-65B5R-Q1SWR  | ±65                | 5               | 30.77              | 125%                       | 3   | SOW16   |
| NSM2017-75B5R-Q1SWR  | ±75                | 5               | 26.67              | 125%                       | 3   | SOW16   |

\*If you need other version, please contact NOVOSENSE for special support



Part Number Rule:

**NSM2017-40B3RX-Q1SWR**

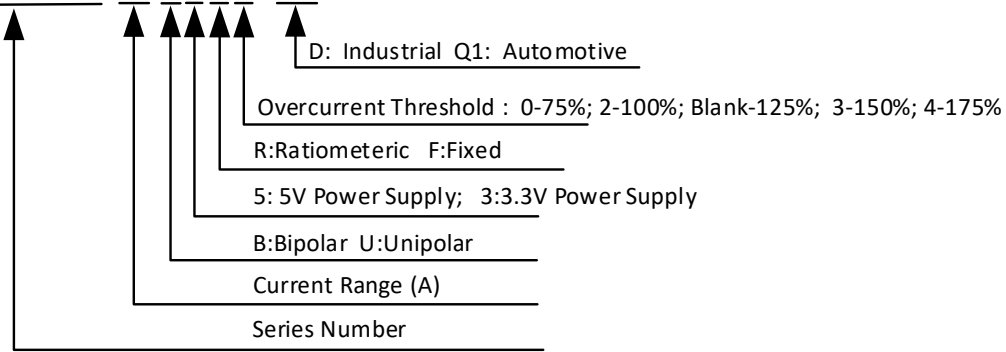

10. Tape and Reel Information

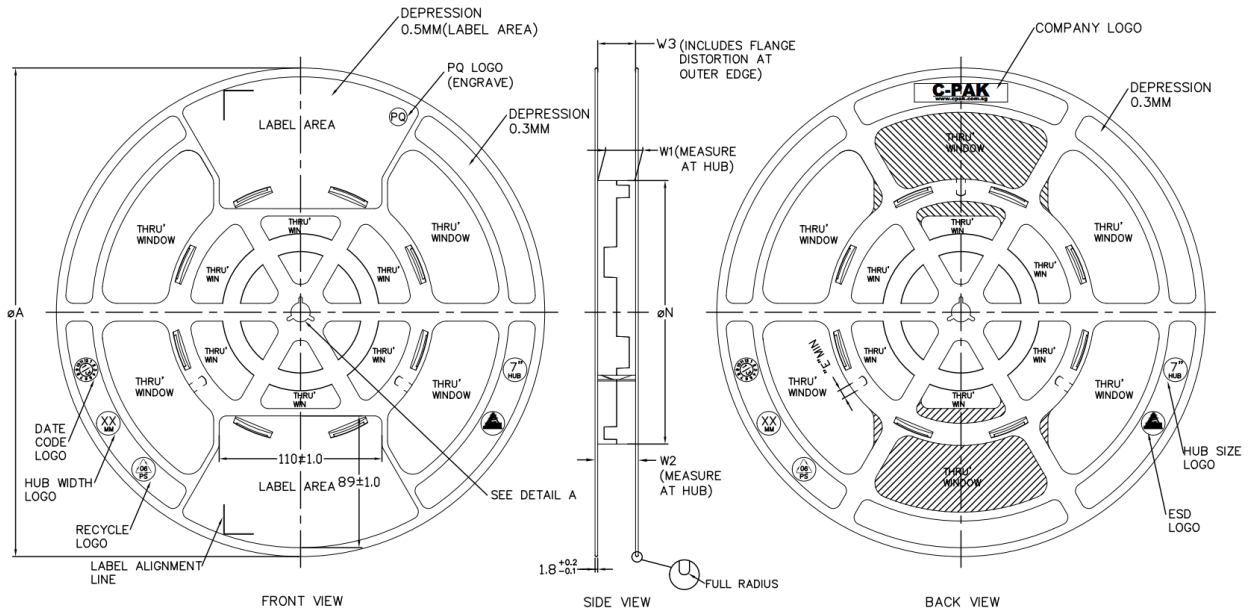

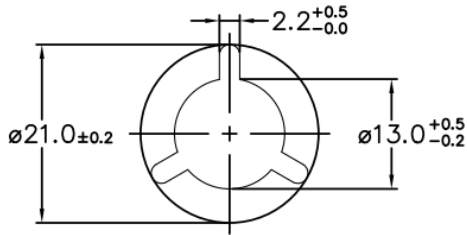

ARBOR HOLE  
DETAIL A  
SCALE : 3:1

| PRODUCT SPECIFICATION |         |         |                |          |   |         |
|-----------------------|---------|---------|----------------|----------|---|---------|
| TAPE WIDTH            | ØA ±2.0 | ØN ±2.0 | W1             | W2 (MAX) | W3  | E (MIN) |
| 08MM                  | 330     | 178     | 8.4 ±1.5/-0.0  | 14.4     | SHALL ACCOMMODATE TAPE WIDTH WITHOUT INTERFERENCE | 5.5     |
| 12MM                  | 330     | 178     | 12.4 ±2.0/-0.0 | 18.4     |   | 5.5     |
| 16MM                  | 330     | 178     | 16.4 ±2.0/-0.0 | 22.4     |   | 5.5     |
| 24MM                  | 330     | 178     | 24.4 ±2.0/-0.0 | 30.4     |   | 5.5     |
| 32MM                  | 330     | 178     | 32.4 ±2.0/-0.0 | 38.4     |   | 5.5     |

| SURFACE RESISTIVITY |   |                      |            |
|---------------------|---|----------------------|------------|
| LEGEND              | SR RANGE                                | TYPE                 | COLOUR     |
| A                   | BELOW 10 <sup>12</sup>                  | ANTISTATIC           | ALL TYPES  |
| B                   | 10 <sup>9</sup> TO 10 <sup>11</sup>     | STATIC DISSIPATIVE   | BLACK ONLY |
| C                   | 10 <sup>5</sup> & BELOW 10 <sup>5</sup> | CONDUCTIVE (GENERIC) | BLACK ONLY |
| E                   | 10 <sup>9</sup> TO 10 <sup>11</sup>     | ANTISTATIC (COATED)  | ALL TYPES  |

Note: MPQ(SOW16):1K

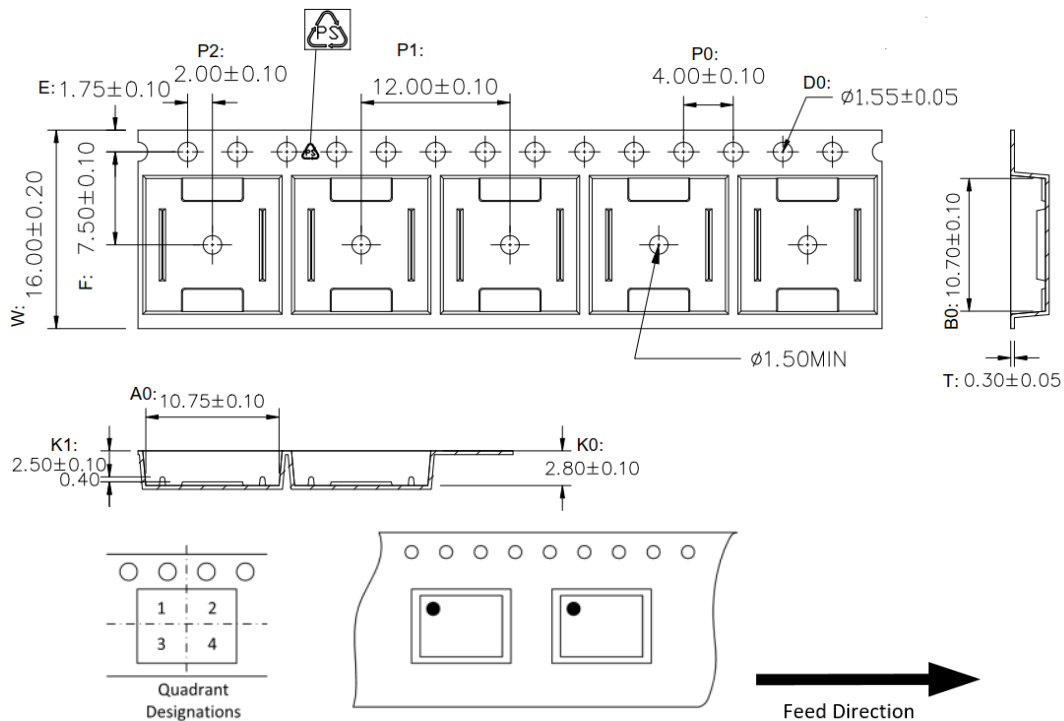

Figure 10.1 Tape and Reel Information of SOW16

## 11. Revision History

| Revision | Description      | Date       |
|----------|------------------|------------|
| 1.0      | Initial Version. | 2023/12/27 |

## IMPORTANT NOTICE

The information given in this document (the “Document”) shall in no event be regarded as any warranty or authorization of, express or implied, including but not limited to accuracy, completeness, merchantability, fitness for a particular purpose or infringement of any third party’s intellectual property rights.

Users of this Document shall be solely responsible for the use of NOVOSENSE’s products and applications, and for the safety thereof. Users shall comply with all laws, regulations and requirements related to NOVOSENSE’s products and applications, although information or support related to any application may still be provided by NOVOSENSE.

This Document is provided on an “AS IS” basis, and is intended only for skilled developers designing with NOVOSENSE’ products. NOVOSENSE reserves the rights to make corrections, modifications, enhancements, improvements or other changes to the products and services provided without notice. NOVOSENSE authorizes users to use this Document exclusively for the development of relevant applications or systems designed to integrate NOVOSENSE’s products. No license to any intellectual property rights of NOVOSENSE is granted by implication or otherwise. Using this Document for any other purpose, or any unauthorized reproduction or display of this Document is strictly prohibited. In no event shall NOVOSENSE be liable for any claims, damages, costs, losses or liabilities arising out of or in connection with this Document or the use of this Document.

For further information on applications, products and technologies, please contact NOVOSENSE ([www.novosns.com](http://www.novosns.com)).

**Suzhou NOVOSENSE Microelectronics Co., Ltd**